

Getting Ready



ENGLISH

[www.emd.wa.gov/preparedness/home.shtml](http://www.emd.wa.gov/preparedness/home.shtml)

Compelling photos. Streaming videos.  
Illustrated step-by-step instruction.

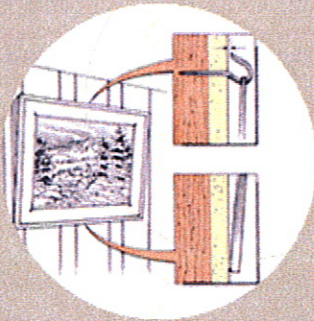

Secure Wall Hangings  
(PDF)

**How to Videos:**  
- Finding a wall stud  
- Secure wall hangings

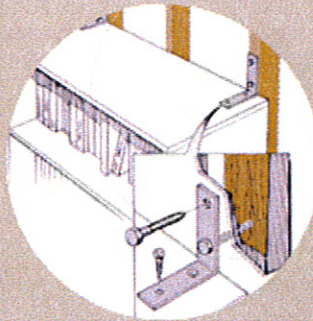

Secure Tall Furniture & Objects  
(PDF)

**How to Videos:**  
- Trip to the hardware store  
- Finding a wall stud  
- Secure with hardware  
- Secure with a strap

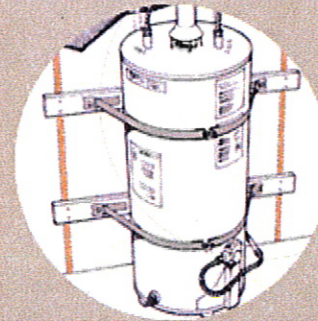

Secure Water Heater  
(PDF)

**How to Videos:**  
- Finding a wall stud

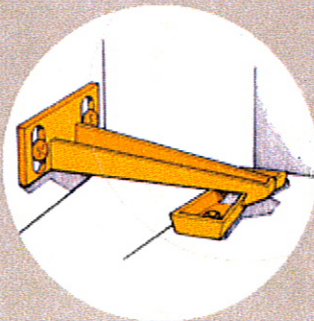

Kitchen & Cabinet Safety (PDF)

**How to Videos:**  
- Secure cabinets  
- Secure dishes/contents

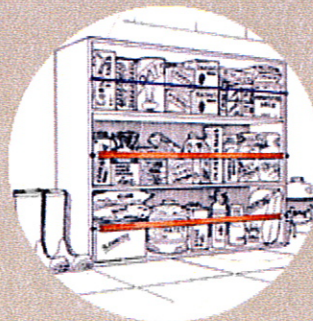

Garage and Storage Safety  
(PDF)

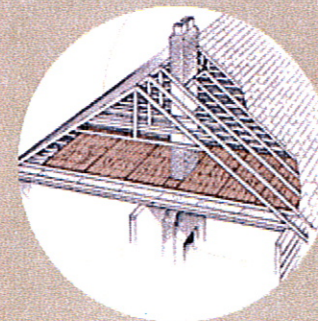

Structural Mitigation  
(PDF)

For a list of local offices of emergency management call: 800.562.6108, or view our website at:  
[www.emd.wa.gov/preparedness/neighborhoods.shtml](http://www.emd.wa.gov/preparedness/neighborhoods.shtml)





# Wall Hangings

## Framed pictures – securing them helps prevent cut feet

The ground swells and rolls of major earthquakes easily can knock heavy pictures and mirrors off the walls. This can be especially dangerous in the night if these unsecured items are located close to your bed, or during the day if they are located close to your favorite chair or sofa.

Cut feet from broken framing glass and mirrors is one of the most common injuries resulting from major earthquakes. Securing your pictures helps prevent this common injury.

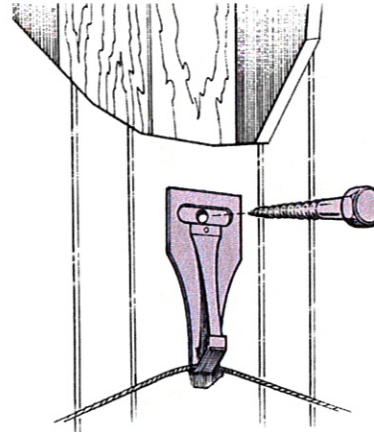

picture hanging hooks that actually close are also a good choice for securing pictures



## Securing artwork, pictures, and mirrors

- Use a stud finder to find the closest wall stud.
- Screw a screw hook into the wall stud so that there is barely enough room to slide the framing wire between the wall and the hook. This will help prevent the wire from jumping off the hook during the potentially violent movement of an earthquake.
- If the artwork or mirror is large and / or heavy, you may want to consider securing it to two wall studs.
- Secure the bottom corners of these items with Quake-Hold™-type products to keep them from banging against the wall. This helps keep the framing glass from breaking and damaging the artwork or photo.

screw hook into wall, leaving just enough space to slide the wire onto the hook

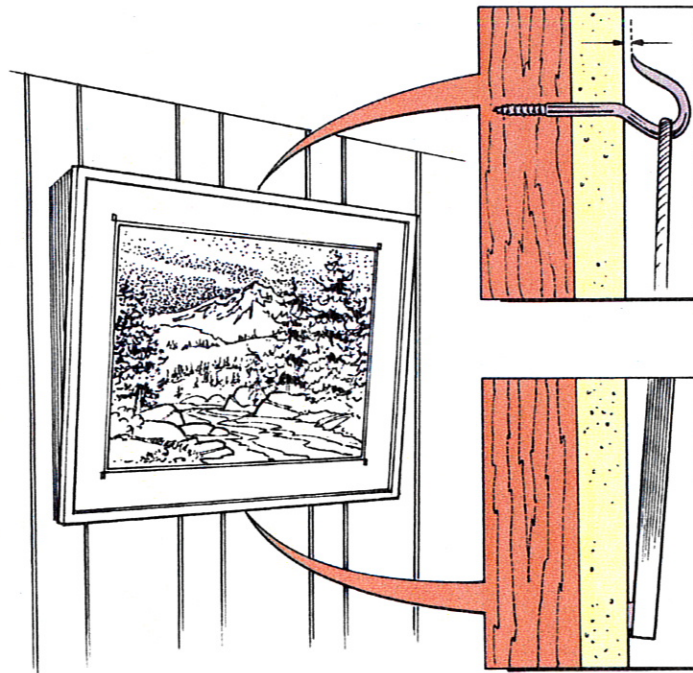

secure bottom corners with Quake-Hold™ or similar product

---

## **Securing hanging objects**

Carefully check the location of all hanging plants and other objects. Determine if these objects are close enough to windows to strike them in the wild motion of an earthquake. If they are, consider moving them.

- Find the ceiling stud by using a stud finder.

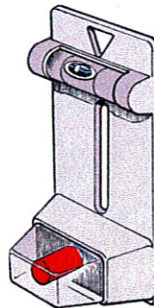

**example of a  
stud finder**

- Screw the hook directly into the ceiling stud.
- Hang the object from this hook.
- Close the opening in the hook with a pair of pliers to prevent the object from leaping off the hook during an earthquake.

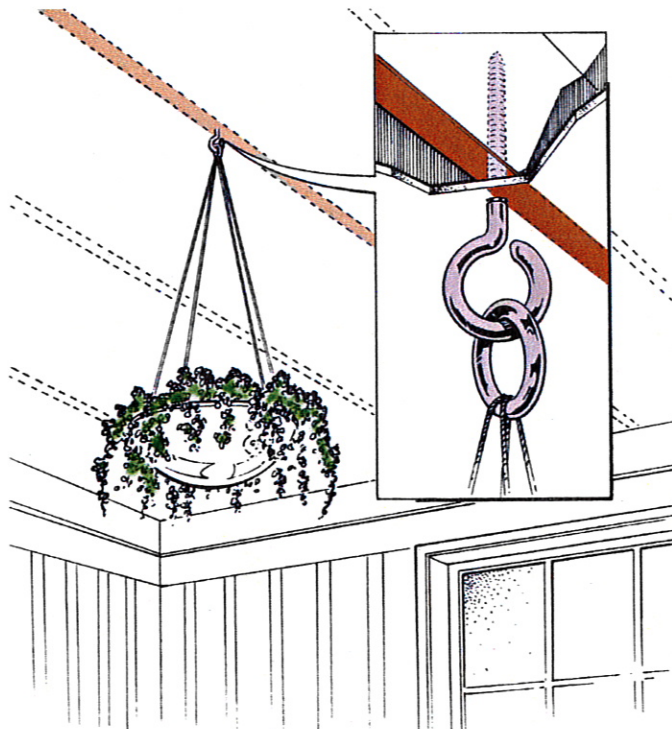



# Securing Tall Furniture

## Earthquakes: A Sudden Release of Energy

The forces that create earthquakes cause the earth literally to quake, producing:

- ground rolling and undulating, from a few inches to a few feet in height,
- ground shaking, from a few seconds to a few minutes in duration.

Tall pieces of furniture, such as bookcases, china hutches, and armoires are very likely to fall when the ground is rolling and shaking. You can prevent them from falling on someone you care about, and save their contents, by completing these simple steps.



## Securing bookcases & all things tall

1. Secure the furniture item to the wall stud.

- locate the wall studs using a stud finder

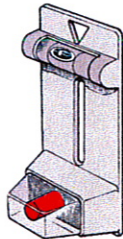

- secure each furniture piece to at least two wall studs, depending on size and weight, using **4" L-brackets** and **3" lag screws**, available at all hardware stores

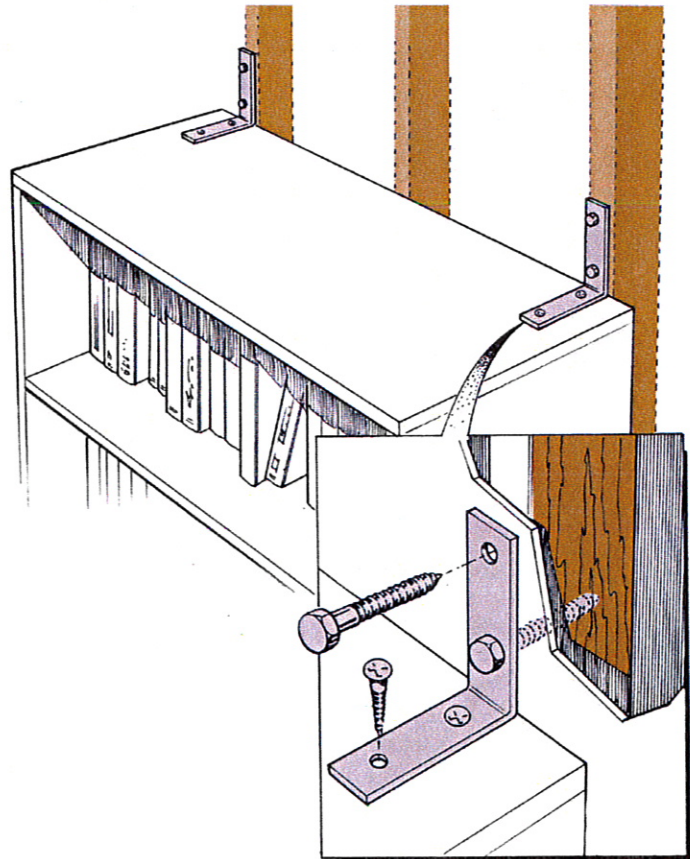

There are commercially available kits utilizing nylon strapping that also are recommended.

- 
2. Place heavy and/or large items on lower shelves to prevent them from flying around the room in an earthquake.

4. More delicate items, like knickknacks, pottery, crystal vases, etc. can be secured with products like Quake Hold™ or Museum Wax™, available at many hardware stores.

3. The ground swells and rolls of an earthquake can cause anything resting on shelf or counter tops to fall – TVs, stereos, computers, microwaves, lamps, etc. An easy way to protect against these types of losses is to use Velcro™ or other similar products.

- Choose a Velcro™-type product that has adhesive on the back.
- Cut the Velcro™ into large squares. You will need four squares to secure most items, one for each leg or corner of the item.
- Press the two sides of the Velcro™ together.
- Remove the paper from the backs of the Velcro™ to expose the adhesive.
- With the Velcro™ still pressed together, stick it on the legs or corners of the item, and then place the item on the shelf or counter top where you want it located.

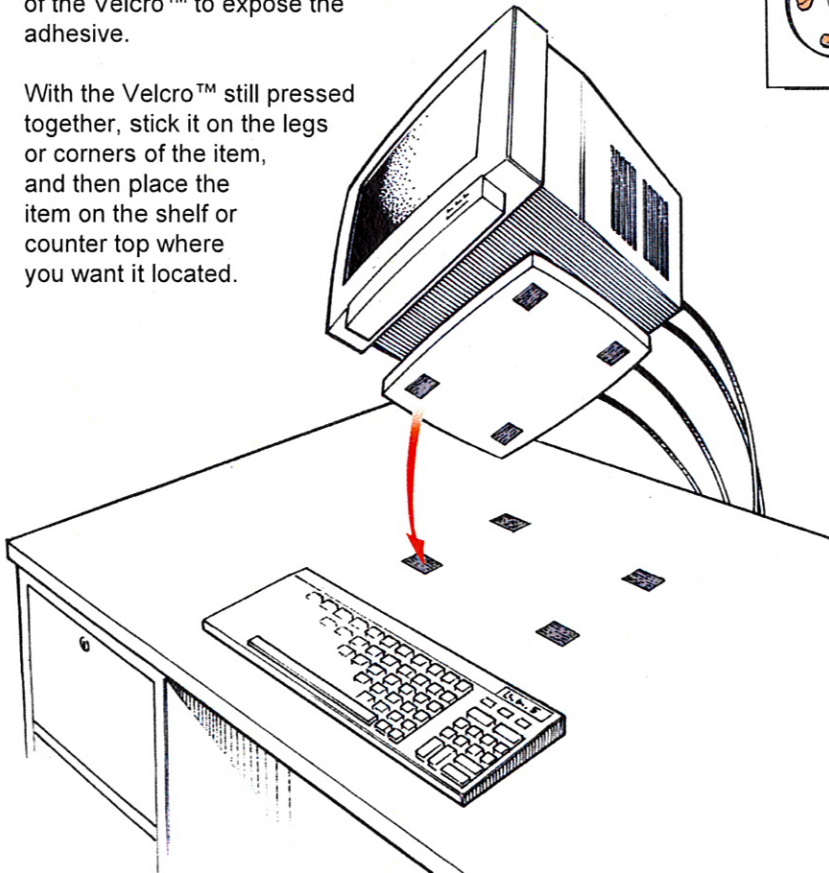
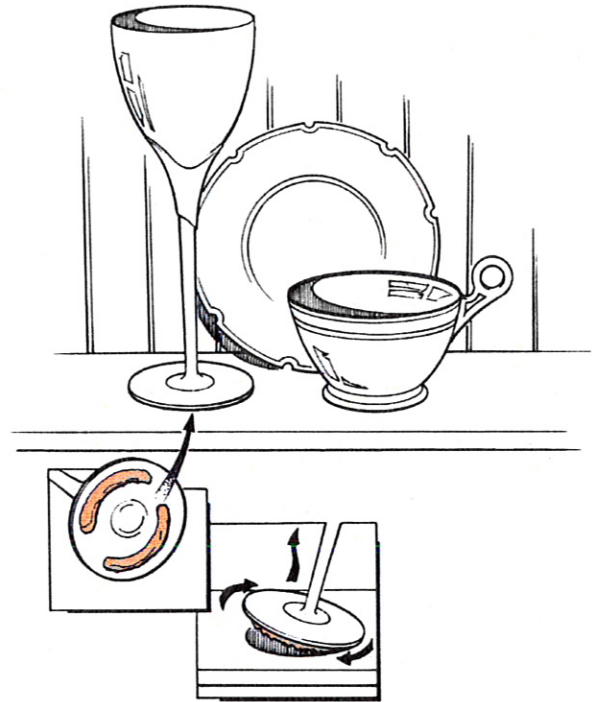



# Kitchen & Cabinet Safety

## Kitchen Cabinets

The ground undulation and acceleration of an earthquake can cause cabinet doors to fly open and contents to spill onto the floor. Glass jars and dishes can shatter and cause injuries and damage. Heavy objects can fly across the room, injuring any in their path or damaging counter tops, floors, or walls.



## Securing kitchen cabinets

To prevent cabinet doors from flying open, install one of the following types of latches:

- A. Hook and eye – inexpensive; you may not close it every time
- B. Standard latch – mounts to the front of the door; you may not close it every time
- C. Standard latch – closes automatically; mounts to the front of the door
- D. Push latches – mounts inside the door; holds the door firmly shut; opens by being pushed gently inward
- E. Child-proof – inexpensive; closes automatically; requires an extra action when you open the door; takes some getting used to

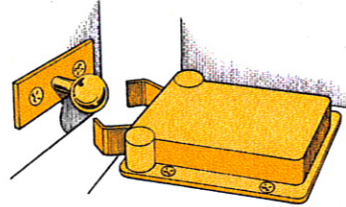

### D. Push latch

- mounts inside cabinet
- opens by pushing gently inward on cabinet door

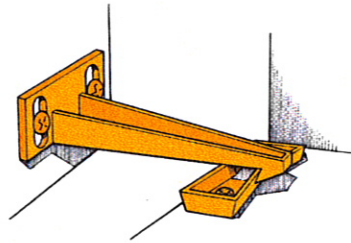

### E. Child-proof latch

- inexpensive
- takes some getting used to - must reach inside cabinet to release latch

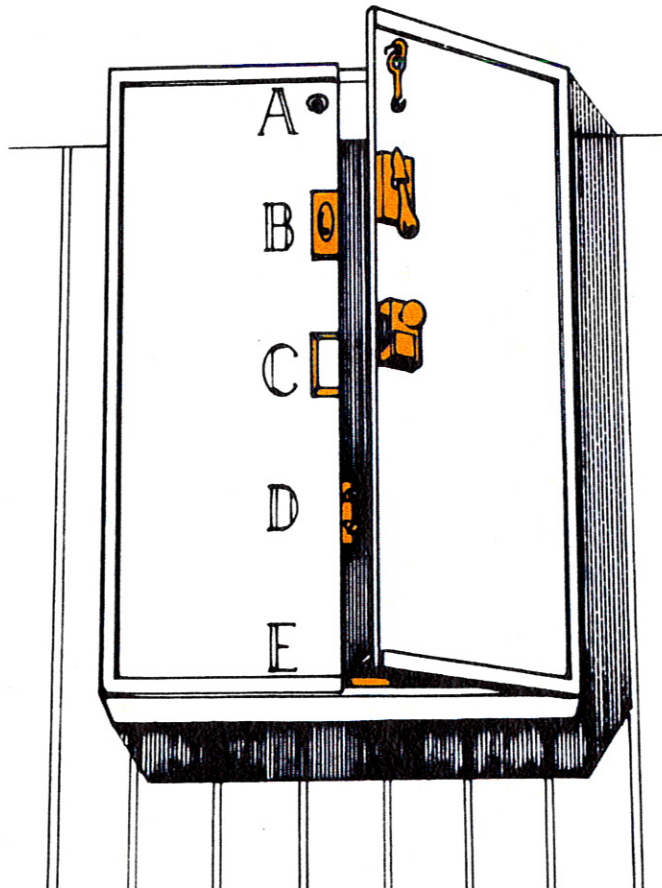

---

## **Securing cabinet contents**

The contents of cabinets may shift and break in the movement of an earthquake. To help prevent this movement, line your cabinets with rubberized shelf mats. This typically is sold in rolls or pre-cut squares at hardware and variety stores. It is also available at recreational vehicle or boating equipment supply stores.

To **protect stacked china plates**, place a square of this rubberized matting between each plate in the stack.

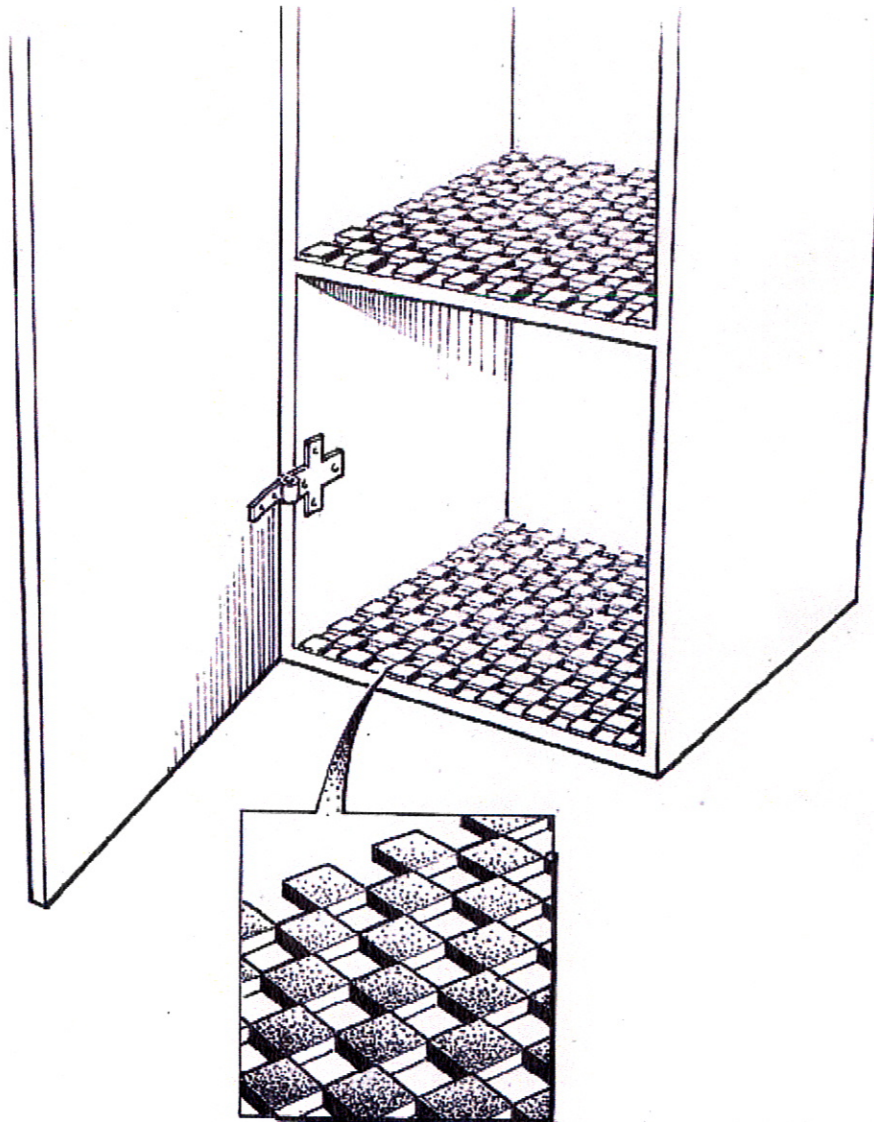



# Securing the Water Heater

## Protected source of water – or a puddle

Fresh water after a disaster may be as close as your water heater – provided, of course, that it remains standing upright. A typical water heater holds 30 to 50 gallons of water.

However, this supply of water is extremely vulnerable to the ground undulation (swells and rolls) and ground acceleration of earthquakes, causing them to tip over.

You can protect this valuable resource by securing your water heater to the wall studs.

## Changes to strapping recommendations

Experts have modified the recommended procedure for strapping water heaters because many tanks burst through their strapping in both the 1989 Loma Prieta (San Francisco) and the 1994 Northridge (Los Angeles) earthquakes. Experts recommend these two important changes:

1. Secure both the top and the bottom, rather than just the top or just the middle, of the hot water tank.
2. Use heavy-gauge metal strapping rather than plumber's tape. Many water heaters in both the 1989 and the 1994 earthquakes burst through the plumber's tape that was intended to keep them secure. Plumber's tape has been found to be too brittle to be effective.

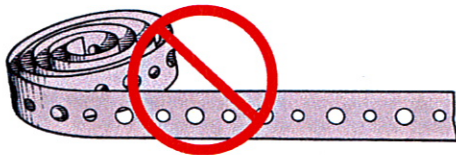

**do NOT use this -  
this is plumber's tape  
use heavy-gauge  
strapping instead**



## Securing your hot water tank

Secure your water heater.

- There should be very little space between the water heater and the wall. If there is more than 1 or 2 inches, attach a wooden block to the wall studs with long lag screws (see illustration on page 17). The purpose is to prevent the heater from tipping backwards.
- Wrap the heavy-gauge metal strapping 1 1/2 times around the tank. Start by placing the strapping at the back of the tank. Bring it to the front and then take it back to the wall (see illustration).
- Secure this strapping to the wall studs or the wood block using several 1/4" x 3" or longer lag screws *with oversized washers*. If you are securing it directly into concrete, use 1/4" expansion bolts in place of the screws.

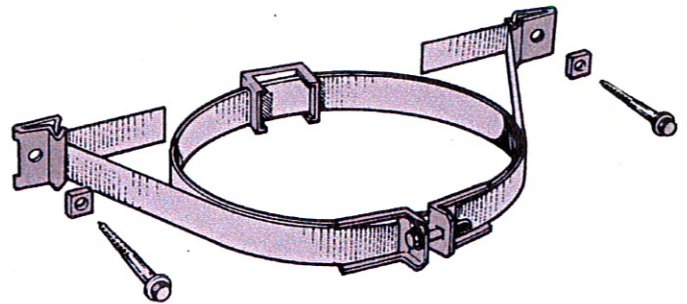

**Commercially available kits like this one come complete with the strapping, lag screws, washers, spacers, and tension bolts. These kits can be purchased at many local hardware stores, and are recommended.**

## NOTE:

- Replace all copper and metal piping with flexible natural gas and water line connectors.



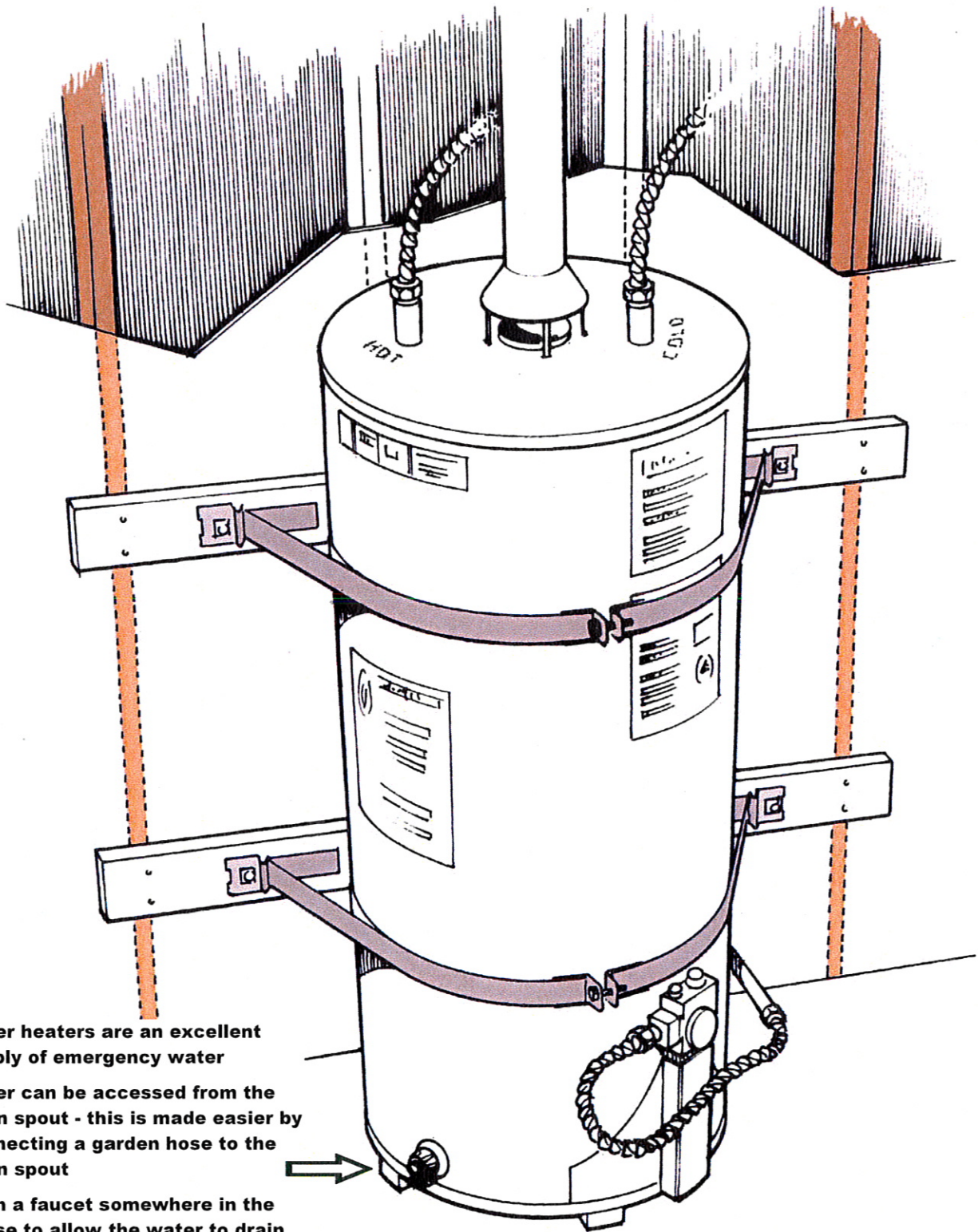

**water heaters are an excellent supply of emergency water**

**water can be accessed from the drain spout - this is made easier by connecting a garden hose to the drain spout**

**open a faucet somewhere in the house to allow the water to drain easier**





# Garage & Storage Safety

## Household chemicals - potentially lethal

The ground movement of earthquakes can cause chemical products you have stored in the garage and under household sinks to spill and potentially mix. These materials can be silent killers or can cause serious injury.



## Before a disaster - secure all chemicals

Secure all chemicals so that they cannot fall, break, and mix.

- Identify poisons, toxins, and solvents in breakable containers on open shelves.
- Remove all heavy objects from upper shelves, especially around the car.
- Secure open shelves with nylon webbing (available at hardware stores, boating supply stores, and many camping supply stores) or bungee-type straps. (Do not use regular bungee straps with the heavy metal hooks at either end. These may become dislodged and cause serious eye or other injuries.)
- Store paints, gasolines, and other flammable liquids away from natural gas water heaters.
- Read the labels on all products you purchase.
- Separate the chemicals according to manufacturers' suggestions to prevent harmful interactions if broken containers should allow the chemicals to mix. For example, household bleach mixed with ammonia creates extremely deadly chlorine gas.
- Know what steps to take if chemicals are spilled.
- Dispose of any hazardous materials that are no longer used.

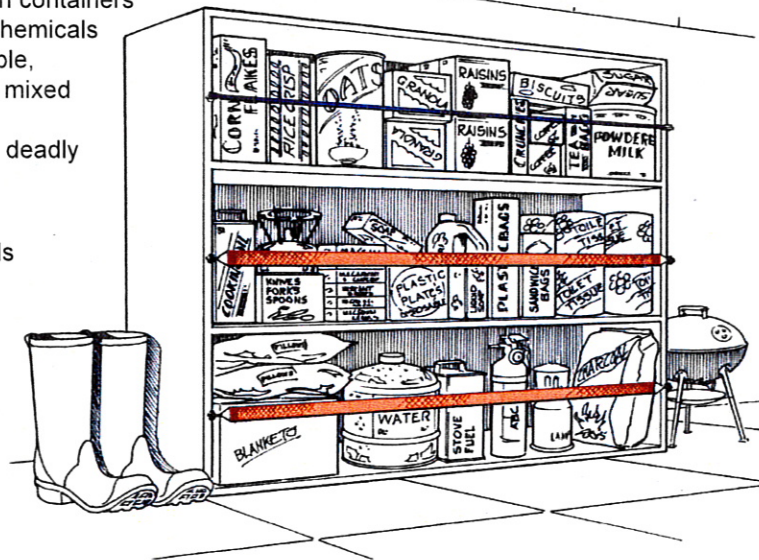

## After a disaster - safety with chemicals

- Always assume that spilled chemicals are toxic.
- Do not immediately approach spilled chemicals in your haste to clean them up. Mixed chemicals can be extremely hazardous.
- Close off the room where the spill has occurred.
- Mark the outside of the room with the problem, for example, "spilled chemicals inside - use caution."
- As soon as possible, notify the fire department that you have a chemical spill.

## Ways hazardous materials enter the body:

- inhalation (breathing) - the most common way
- absorption - through skin or eyes
- ingestion - swallowing
- injection - penetrating the skin or falling on something that punctures the skin

## Indicators that a spill has taken place

- pungent or noxious odor - never intentionally get close enough to smell it
- bubbling liquid
- vapor - anything that is releasing a vapor is having a chemical reaction and should be avoided





# Structural Mitigation

## Wood-framed homes – safe & sound?

Homes that have been framed in wood are generally quite resistant to earthquake damage. While it is unlikely that conventionally framed houses will collapse, your assurances of safety are dramatically improved if the home remains on its foundation, and the roof, ceiling, and walls remain connected. If you have specific questions about your home, please contact an engineer experienced in seismic strengthening. These can be found in the yellow pages of the phone book.



## Securing your foundation

The majority of residential structural damage is caused by homes sliding off their foundations during major earthquakes.

- Check your house and garage for foundation bolts. These bolts secure the wood structure to the concrete foundation. They should be placed every six feet along the sill plate.
- Using a hammer drill and a carbide bit, drill a hole through the sill plate into the foundation. Place these holes every six feet.
- Drop a 1/2" x 8" expansion bolt into the hole and tighten the nut.

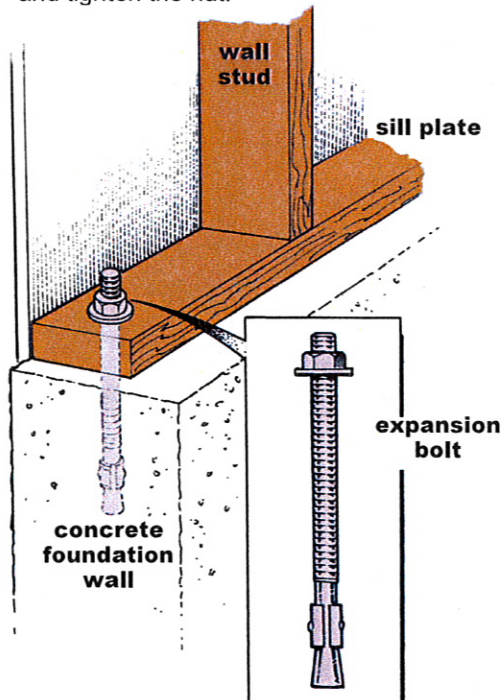

## Cripple walls

- Inspect the vertical studs that extend from the foundation to the first floor of your home. These are common in crawl space areas and are called cripple walls. If they are exposed (for example, without sheathing) on the inside, they could buckle in the ground motion that accompanies many large earthquakes.
- Strengthen the cripple walls by nailing plywood sheathing to the vertical studs, sill plate, and top plate.

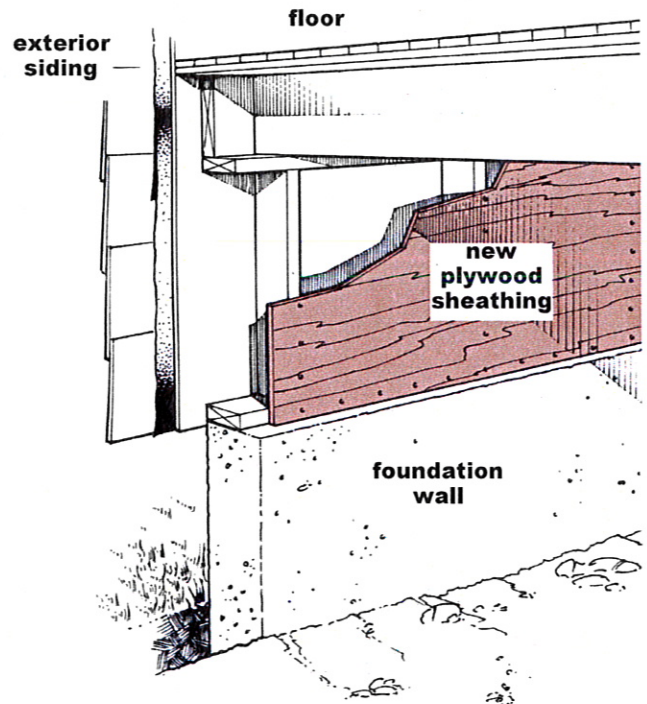

**CAUTION: Retrofitting done improperly may actually cause damage to your home during an earthquake.**

These pages are intended to illustrate the types of structural retrofitting houses need to be seismically safe. They are NOT intended to provide the specific directions on how to do the retrofitting.

Check with your local office responsible for issuing building permits for complete instructions.

## **Strengthening the frame**

For a building to stay together in an earthquake, all its parts must be fastened together. Commercially available metal connectors are used to strengthen places where beams, posts, walls, the floor, and the ceiling join.

- Strengthen the connections between ceilings, walls, and floors using the appropriate hardware:

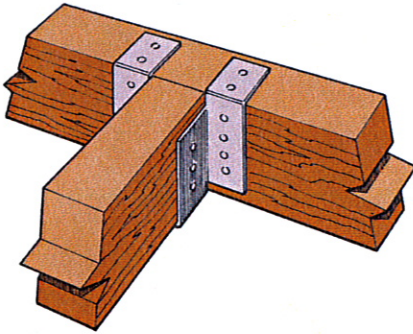

- Inspect all exposed framing in garages, basements, porches, and patio covers. Strengthen this where necessary.

## **Brick & masonry facades**

- Check all brick, masonry, and stone facades to make sure they are securely attached to your home. Consult a structural engineer for advice on how to do this.

## **Chimney**

One of the most common types of damage suffered in earthquakes is a toppled chimney. This becomes extremely dangerous when bricks penetrate the roof and fall to the rooms below.

- Check the chimney for loose tiles and bricks.
- Reinforce the ceiling surrounding the chimney with 3/4" plywood nailed to the beams. This provides protection from falling bricks that might break through the roof.

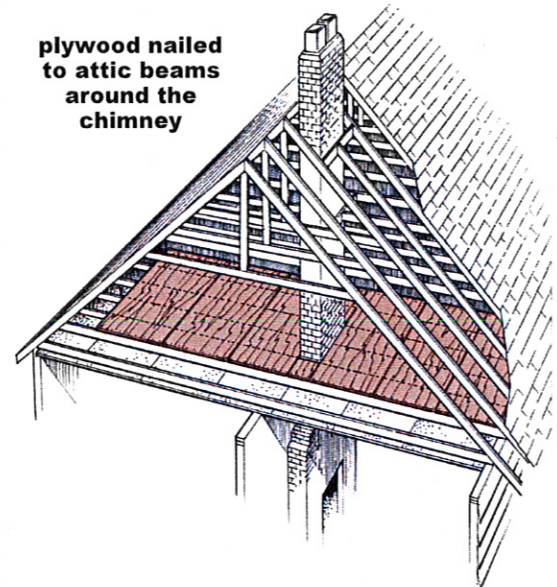

- If your chimney is old and extends more than five feet above the roof, consider bracing it. Check the yellow pages in the phone book for engineers who are experienced in seismic strengthening.

## **Windows**

- Inspect all large plate glass windows to make sure they are safety glass.
- Consider adding a safety film to all windows. This does not prevent the window from breaking, but it does keep the glass from falling and injuring loved ones.

